

BLACKMER SEAL-LESS PUMPS

INSTALLATION OPERATION AND MAINTENANCE INSTRUCTIONS
MODELS: SMVP50B, SMVP100B, SMVP200B, SMVP300B

960902

INSTRUCTIONS NO. 108-B00

Section	108
Effective	April 2007
Replaces	April 2005

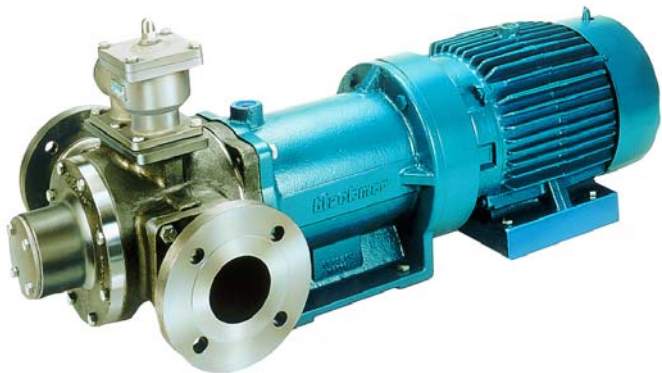

SAFETY DATA

TABLE OF CONTENTS	Page
PUMP DATA	
Technical Data.....	2
Initial Pump Start Up Information.....	2
INSTALLATION	
Pre-Installation Cleaning.....	3
Location and Piping	3
Check Valves.....	3
Pump Mounting.....	3
Motor Installation	4
OPERATION	
Pre-Start Up Check List.....	5
Start Up Procedures	5
Pump Rotation	5
Reverse Rotation	5
Flushing the Pump.....	5
Pump Relief Valve	6
Relief Valve Setting and Adjustment	6
MAINTENANCE	
Strainers	7
Lubrication	7
Vane Replacement	8
Pump Disassembly.....	8
Pump Assembly.....	9
TROUBLE SHOOTING	11

NOTE: Numbers in parentheses following individual parts indicate reference numbers on Blackmer Parts Lists 108-B02 and 108-B03.

NOTE: Blackmer pump manuals & parts lists may be obtained from Blackmer's website (www.blackmer.com) or by contacting Blackmer Customer Service



This is a SAFETY ALERT SYMBOL.

When you see this symbol on the product, or in the manual, look for one of the following signal words and be alert to the potential for personal injury, death or major property damage



Warns of hazards that WILL cause serious personal injury, death or major property damage.



Warns of hazards that CAN cause serious personal injury, death or major property damage.



Warns of hazards that CAN cause personal injury or property damage.

NOTICE:

Indicates special instructions which are very important and must be followed.

NOTICE:

Blackmer Seal-Less pumps **MUST** only be installed in systems, which have been designed by qualified engineering personnel. The system **MUST** conform to all applicable local and national regulations and safety standards.

This manual is intended to assist in the installation and operation of the Blackmer Seal-Less pumps, and **MUST** be kept with the pump.

Blackmer Seal-Less pump service shall be performed by qualified technicians **ONLY**. Service shall conform to all applicable local and national regulations and safety standards.

Thoroughly review this manual, all instructions and hazard warnings, **BEFORE** performing any work on the Blackmer Seal-Less pumps.

Maintain **ALL** system and Blackmer Seal-Less pump operation and hazard warning decals.

SAFETY DATA

⚠ WARNING



Hazardous or toxic fluids can cause serious injury.

If pumping hazardous fluids, system must be flushed, prior to performing service or maintenance

⚠ WARNING



Hazardous pressure can cause personal injury or property damage

Disconnecting fluid or pressure containment components during pump operation can cause serious personal injury, death or major property damage

⚠ WARNING



Hazardous voltage. Can shock, burn or cause death.

Failure to disconnect and lockout electrical power before attempting maintenance can cause shock, burns or death

⚠ WARNING



Do not operate without guards in place

Operation without coupling guard can cause serious personal injury, death or major property damage

⚠ WARNING



Hazardous machinery can cause serious personal injury

Failure to disconnect and lockout electrical power or engine drive before attempting maintenance can cause serious personal injury or death

⚠ WARNING



Strong Magnetic field

Strong magnetic field can cause personal injury or death to individuals with medical implants or other magnetic field sensitive medical conditions

⚠ WARNING



Explosive atmosphere can cause serious injury

Rare earth magnets may create sparks through contact and handling. Never handle rare earth magnets in explosive atmospheres where sparking may ignite that atmosphere

⚠ CAUTION



Strong magnetic field can cause personal injury

Failure to use care when handling magnets can cause personal injury

⚠ WARNING



Hazardous pressure can cause serious personal injury or property damage

Failure to relieve system pressure prior to performing pump service or maintenance can cause personal injury or property damage.

PUMP DATA

PUMP IDENTIFICATION

A pump identification tag, containing the pump serial number, ID number, and model designation, is attached to each pump. It is recommended that the data from this tag be recorded and filed for future reference. If replacement parts are needed, or if information pertaining to the pump is required, this data must be furnished to a Blackmer representative.

TECHNICAL DATA

PUMP MODEL	SMVP50B, SMVP100B	SMVP200B SMVP300B
Maximum Pump Speed	1750 RPM	1150 RPM
Maximum Operating Temperature	200°F (93°C)	200°F (93°C)
Minimum Operating Temperature	-40°F (-40°C)	-40°F (-40°C)
Maximum Viscosity	10,000 SSU (2,200 CP)*	25,000 SSU (5,250 CP)*
Maximum Differential Pressure	125 psi (8.6 bar)	100 psi (6.9 bar)
Maximum Working Pressure = Inlet Pressure + Differential Pressure	175 psi (12.1 bar)	150 psi (10.3 bar)

Technical Data is for standard materials of construction. Consult Blackmer Material Specs for optional materials of construction.

* Conversion is based on a specific gravity of 1.0.

INITIAL PUMP START UP INFORMATION

Model No.: _____

Serial No.: _____

ID No.: _____

Date of Installation: _____

Inlet Gauge Reading: _____

Discharge Gauge Reading: _____

Flow Rate: _____

INSTALLATION

NOTICE:

Blackmer seal-less pumps must only be installed in systems designed by qualified engineering personnel. System design must conform with all applicable regulations and codes and provide warning of all system hazards.

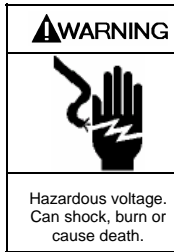

- ▲ Install, ground and wire to local and National Electrical Code requirements.
- ▲ Install an all-leg disconnect switch near the unit motor.
- ▲ Disconnect and lockout electrical power before installation or service
- ▲ Electrical supply **MUST** match motor nameplate specifications.

▲ Motors equipped with thermal protection automatically disconnect motor electrical circuit when overload exists. Motor can start unexpectedly and without warning.

PRE-INSTALLATION CLEANING

NOTICE:

New pumps contain residual test fluid and rust inhibitor. If necessary, flush pump prior to use.

Foreign matter entering the pump WILL cause extensive damage. The suction tank and piping MUST be cleaned and flushed prior to pump installation and operation.

LOCATION AND PIPING

An improperly designed piping system or improper unit installation WILL significantly reduce pump performance and life. Blackmer recommends the following piping system layout and unit installation.

1. To minimize intake losses, locate the pump as close as possible to the source of supply.
2. Intake piping and fittings MUST be at least as large in diameter as the pump intake connection.
3. Minimize the number of intake line fittings (valves, elbows, etc.) and piping turns or bends.
4. It is recommended an intake strainer be installed at least 24" (0.6m) from the pump intake. For viscosities less than 1000 SSU the strainer should have a net open area of at least four times the area of the intake pipe. For viscosities greater than 1000 SSU consult the strainer manufacturer instructions. Strainers must be cleaned regularly to avoid pump starvation.
5. Intake and discharge piping MUST be free of all leaks.
6. Expansion joints, placed at least 36" (0.9m) from the pump, will compensate for expansion and contraction of the pipes. Contact the flexible connector/hose manufacturer for required maintenance/care and design assistance in their use.
7. Install vacuum and pressure gauges in the 1/4" NPT ports provided in the pump cylinder to check pump at start up.
8. ALL piping and fittings MUST be properly supported to prevent any piping loads from being placed on the pump.

9. Check alignment of pipes to pump to avoid strains which might later cause misalignment. See Figure 1. Unbolt flanges or break union joints. Pipes should not spring away or drop down. After pump has been in operation for a week or two, completely recheck alignment.

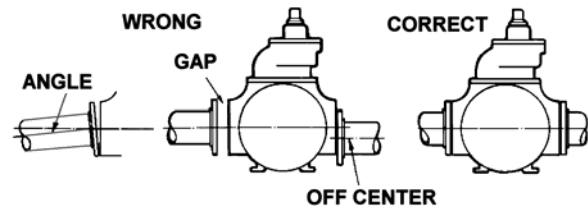

Figure 1

10. When pumping liquids at elevated temperature, provisions should be made to compensate for expansion and contraction of the pipes, especially when long pipe lines are necessary. Steel pipe expands approximately 3/4" (1.9 cm) per 100 feet (30.49 m) per 100°F (37.8°C) rise in temperature.

CHECK VALVES

The use of check valves or foot valves in the supply tank is not recommended with self-priming, positive displacement pumps.

If the possibility of liquid backflow exists when the pump is off, a check valve in the pump discharge piping is recommended because the pump can motor in the reverse rotation and create undue stress on all attached components. Never start a pump when it is rotating in the reverse rotation as the added starting torque can damage the pump and related equipment.

PUMP MOUNTING

Permanently mount the unit by securing the base plate with adequately sized anchor bolts to a level concrete floor following recommended industry standards. A solid foundation will reduce system noise and vibration, and will improve pump performance. Refer to ANSI/HS standards or a suitable pump handbook for information on typical pump mounting and foundations.

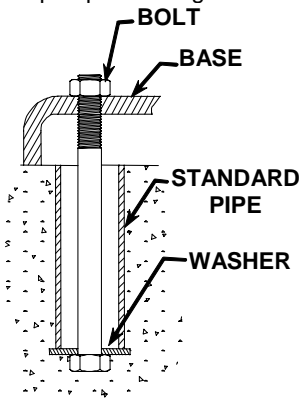

When using a foot mounted 284-286TC motor frame for SMVP200B/300B models or a foot mounted 254-256TC motor frame for SMVP50B/100B models, shims are required under the magnet housing to support the motor frame.

INSTALLATION

MOTOR INSTALLATION

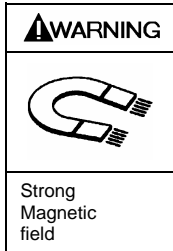

Strong magnetic field can cause personal injury or death to individuals with medical implants or other magnetic field sensitive medical conditions

Strong Magnetic field

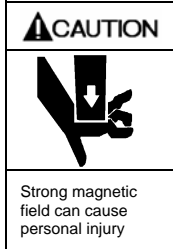

Failure to use care when handling magnets can cause personal injury

Strong magnetic field can cause personal injury

NOTICE:

Clear work area of all tools and materials affected by magnets. Non-magnetic work surface recommended.

MAGNET SET

- Put drive key in keyway on motor shaft.
- Loosely assemble bushing with bolts & outer magnet. Slide magnet assembly onto motor shaft.
- Position bushing and magnet to Reference Dim "B", (see Table 1) and tighten setscrew over drive key.
- Tighten the 3 bolts in a uniform sequence.
On SMVP50B/100B models: torque to 9 ft lbs. (12.2 Nm)
On SMVP200B/300B models: torque to 15 ft lbs. (20.3 Nm)

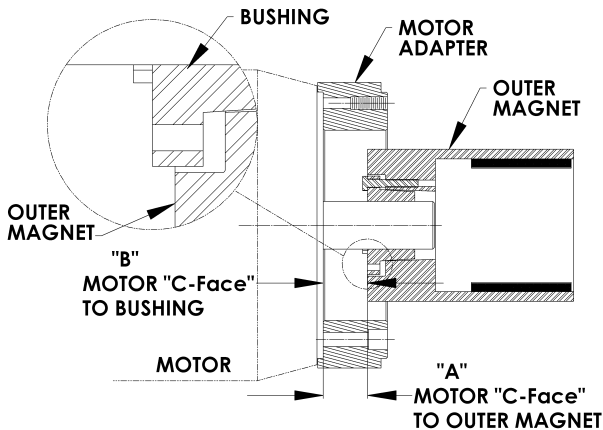

Figure 2

PUMP MODEL	MOTOR FRAME	DIM "A" MAGNET SET		DIM "B" BUSHING SET	
		INCH	MM	INCH	MM
SMVP50B, SMVP100B	182TC / 184TC / 213TC / 215TC	1.231	31.3	1.221	31.0
	254TC / 256TC	1.731	44.0	1.721	43.7
SMVP200B, SMVP300B	213TC / 215TC	1.117	28.4	1.107	28.1
	284TC / 286TC	1.747	44.4	1.737	44.1

Table 1

- When bolts are tightened, take a measurement for Dim "A". (see table 1)
- If Measurement "A" does not match the value in the Table, the bushing **MUST** be repositioned with a new Dim "B". Loosen the bolts and setscrew.
If Measurement "A" is **High**:
Move the bushing towards the motor "C-Face"
New Dim "B" = table Dim "B" less the difference between Measurement "A" and table Dim "A".
If Measurement "A" is **Low**:
Move the bushing away from the motor "C-Face"
New Dim "B" = table Dim "B" plus the difference between Measurement "A" and table Dim "A".
- Retighten setscrew over drive key. Repeat Steps 4 – 6.
- When Dim "A" is set correctly.** Ensure that Shaft & Outer Magnet assembly rotate freely without binding
- Slide the motor adapter ring (86) over the outer magnet to the "C-Face" of the motor. Ensure that the flange of the motor adapter ring is fully and squarely seated.
On the SMVP50B/100B and MVP50B/100B models the housing capscrews (54B), installed in step 12, will secure the adapter in place.
On SMVP200B/300B models install the four adapter/motor capscrews (56), torquing to 27lbs ft (36.6 Nm). Starting from the pump side of the magnet housing (57), thread the two jackscrews (54C) into the jackscrew holes in the housing until they extend through approximately 2 inches.

NOTICE:

Be prepared for strong magnet attraction between the inner and outer magnets, forcibly pulling the motor coupling adapter assembly inward.

- Ensure that the magnet housing (57) is bolted to the base.
- Using an appropriately sized hoist, CAREFULLY insert the outer magnet and motor into the mounted magnet housing (57).
- On SMVP200B/300B models, gradually unscrew the jackscrews to allow the motor to fully engage in the housing.
- With the magnet housing fully and squarely seated, install the four housing capscrews (54B) and torque to:
SMVP50B/100B 27 lbs ft (36.6 Nm)
SMVP200B/300B 27 lbs ft (36.6 Nm)

OPERATION

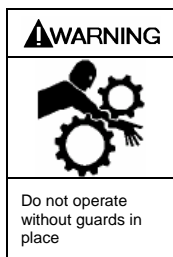

Operation without coupling guard can cause serious personal injury, death or major property damage

Do not operate without guards in place

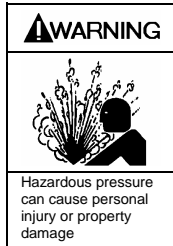

Disconnecting fluid or pressure containment components during pump operation can cause serious personal injury, death or major property damage

Hazardous pressure can cause personal injury or property damage



Operating pump against a closed valve can cause system component failure, personal injury and property damage

Hazardous pressure can cause personal injury or property damage



Failure to relieve system pressure prior to performing pump service or maintenance can cause personal injury or property damage.

Hazardous pressure can cause personal injury or property damage

PRE-START UP CHECK LIST

1. Check the alignment of the pipes to the pump. Pipes should be supported so that they do not spring away or drop down when pump flanges or union joints are disconnected.
2. Inspect complete piping system to ensure all valves and fittings are in their start up or operation positions.
3. Ensure all electrical connections are correct and tight.
4. Jog the pump motor to ensure free and CLOCKWISE pump rotation, as viewed from the fan end of the motor.

START UP PROCEDURES

NOTICE:

Consult the "troubleshooting" section of this manual if difficulties are experienced during start up.

1. Start the motor. Priming should occur within one minute.
2. Check the vacuum and pressure gauges installed on the pump to ensure the pump is operating within the acceptable parameters. Record the gauge readings in the "Initial Pump Start Up Information" section.
3. If possible, check the flow rate to ensure the pump is operating within expected parameters.

4. Inspect piping, fittings and associated system equipment for leaks, noise, vibration and overheating.
5. If equipped, check the pressure relief setting of the pump relief valve by gradually closing a valve in the discharge line momentarily and noting the reading on the pressure gauge. This pressure reading should be 10-20 psi (.69 – 1.4 bar) higher than the maximum system operating pressure. **DO NOT run the pump for more than 15 seconds with the discharge valve completely closed.** If adjustments need to be made, refer to "Relief Valve Setting and Adjustment."

PUMP ROTATION

The pump models described in this manual are designed as RIGHT HAND pumps ONLY, with CLOCKWISE rotation. When viewing the pump from the drive end (motor end), the pump intake port must always be on the right, and the discharge port on the left.

REVERSE ROTATION

NOTICE:

Magnetic coupled pumps should be operated in reverse rotation for no more than 10 minutes, and only when a separate pressure relief valve is installed to protect the pump from excessive pressure.

It may be desirable to operate the pump in reverse rotation for system maintenance. The pump will operate satisfactorily for a LIMITED time, at a reduced performance level.

FLUSHING THE PUMP

NOTICE:

If flushing fluid is to be left in the pump for an extended time, it must be a lubricating, non-corrosive fluid. If a corrosive or non-lubricating fluid is used, it must be flushed from the pump immediately.

1. To flush the pump, run the pump with the discharge valve open and the intake valve closed. Bleed air into the pump through the intake gauge plug hole or through a larger auxiliary fitting in the intake piping. Pump air for 30-second intervals to clean out most of the pumpage.
2. Run a system compatible flushing fluid through the pump for one minute to clear out the remainder of the original pumpage.
3. To remove the flushing fluid, follow step 1 above.

On SMVP models any remaining fluid in the pump can be drained from the cylinder through the drain plugs (73A).

On SMVP200B/300B models drain plugs are also located in the inboard head.

NOTICE:

After flushing the pump some residual fluid will remain in the pump and piping.

NOTICE:

Properly dispose of all waste fluids in accordance with the appropriate standards and regulations.

OPERATION

PUMP RELIEF VALVE

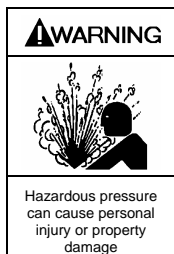

An external bypass valve and/or internal relief valve **must** be installed in the system to protect the pump from excessive pressure.

The SMVP50B, SMVP100B, SMVP200B, SMVP300B pump models are offered with an optional pump relief valve assembly that bolts onto the pump cylinder. Blackmer STRONGLY RECOMMENDS the installation of the optional relief valve to protect the pump from excessive pressure, and a separate system pressure control valve to protect the system from excessive pressure

NOTICE:

The pump relief valve is designed to protect the pump from excessive pressure and must not be used as a system pressure control valve.

Pumping volatile liquids under suction lift may cause cavitation. Partial closing of the discharge valve WILL result in internal relief valve chatter and is NOT recommended. For these applications, install an external system pressure control valve, and any necessary bypass piping, back to the storage tank.

A system pressure control valve is also recommended when operating for extended periods (more than 1 minute) against a closed discharge valve.

RELIEF VALVE SETTING AND ADJUSTMENT

The factory relief valve pressure setting is marked on a metal tag attached to the valve body. It is recommended the relief valve be set at least 10-20 psi (.69-1.4 bar) higher than the operating pressure or the system pressure control valve setting.

DO NOT remove the R / V Cap OR adjust the relief valve pressure setting while the pump is in operation.

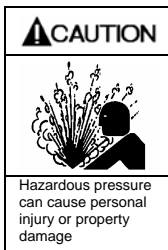

Incorrect settings of the pressure relief valve can cause pump component failure, personal injury and property damage

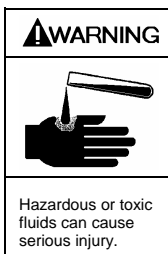

Relief valve cap is exposed to pumpage and will contain some fluid

RELIEF VALVE ADJUSTMENT PROCEDURE:

1. To INCREASE the pressure setting, remove the relief valve cap (1) and O-ring / gasket (88), and turn the adjusting screw (2) inward, or CLOCKWISE. Install a new R/V O-ring / gasket (88), and re-attach the R/V cap.
2. To DECREASE the pressure setting, remove the relief valve cap (1) and O-ring / gasket (88), and turn the adjusting screw (2) outward, or COUNTERCLOCKWISE. Install a new R/V O-ring / gasket (88), and re-attach the R/V cap.

Refer to corresponding Blackmer pump parts lists for relief valve spring pressure ranges. Unless specified otherwise, pumps are supplied from the factory with the relief valve adjusted to the mid-point of the spring range.

MAINTENANCE

⚠ WARNING



Hazardous voltage. Can shock, burn or cause death.

Failure to disconnect and lockout electrical power before attempting maintenance can cause shock, burns or death

⚠ WARNING



Hazardous or toxic fluids can cause serious injury.

If pumping hazardous fluids, system must be flushed, prior to performing service or maintenance

⚠ WARNING



Strong Magnetic field

Strong magnetic field can cause personal injury or death to individuals with medical implants or other magnetic field sensitive medical conditions

⚠ WARNING



Explosive atmosphere can cause serious injury

Rare earth magnets may create sparks through contact and handling. Never handle rare earth magnets in explosive atmospheres where sparking may ignite that atmosphere

⚠ WARNING



Hazardous machinery can cause serious personal injury

Failure to disconnect and lockout electrical power or engine drive before attempting maintenance can cause serious personal injury or death

⚠ WARNING



Hazardous pressure can cause serious personal injury or property damage

Failure to relieve system pressure prior to performing pump service or maintenance can cause personal injury or property damage.

⚠ WARNING



Do not operate without guard in place

Operation without guards in place can cause serious personal injury, major property damage, or death.

⚠ WARNING



Hazardous pressure can cause serious personal injury or property damage

Disconnecting fluid or pressure containment components during pump operation can cause serious personal injury, death or major property damage

⚠ CAUTION



Strong magnetic field can cause personal injury

Failure to use care when handling magnets can cause personal injury

NOTICE:

Maintenance shall be performed by qualified technicians only, following the appropriate procedures and warnings as presented in this manual.

NOTICE:

Properly dispose of all waste fluids according to state and local regulations.

NOTICE:

Clear the work area of all tools and materials affected by magnets. Non-magnetic work surface recommended.

STRAINERS

Adequately sized system strainers are recommended. Strainers MUST be kept clean to ensure adequate fluid flow to the pump. Failure to do so can cause pump cavitation and system damage.

LUBRICATION

NOTICE:

To avoid possible entanglement in moving parts do not lubricate the optional motor coupling adaptor or any other parts while the pump is running.

Pump sleeve bearings are lubricated by the pumpage. No other lubrication is required. For motor lubrication, refer to the manufacturer's instructions.

MAINTENANCE

VANE REPLACEMENT

1. Drain the pump and system, as required.
Drain plugs (73A) are located at the base of the cylinder of SMVP Models. On SMVP200B/300B models drain plugs are also located in the inboard head.
2. For replacement of the vanes ONLY, remove the outboard head, following steps 10 and 11 in the "Pump Disassembly" section of this manual.
3. Turn the shaft by hand until a vane (14) comes to the top (12 o'clock) position of the rotor. Remove the vane.
4. Install a new vane, ensuring that the rounded edge is UP (facing outward) and that the relief grooves are facing TOWARDS the direction of rotation. See Figure 3.
5. Repeat steps 2 and 3 until all vanes have been replaced.
6. To reassemble, follow steps 2 through 7 in the "Pump Assembly" section of this manual.

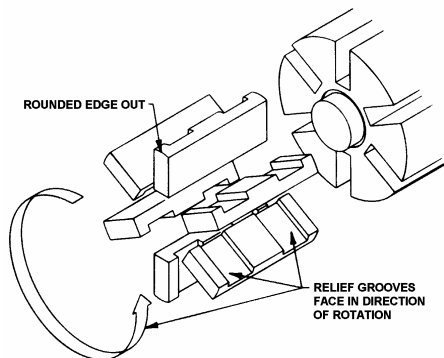

Figure 3 - Vane Installation

PUMP DISASSEMBLY

NOTICE:

The magnet housing (57) should remain mounted to its base during pump disassembly. If removed, the magnet housing (57) must be secured before pump disassembly.

1. Drain the pump and system, as required.
Drain plugs (73A) are located at the base of the cylinder of SMVP Models. On SMVP200B/300B models drain plugs are also located in the inboard head.
2. Disconnect the piping from the pump intake and discharge connections.
3. Remove the four magnet housing/head capscrews (54A)

NOTICE:

Be prepared for strong magnetic attraction between the inner and outer magnets, forcibly pulling the pump assembly inward.

4. On SMVP50B/100B models: While facing the outboard end of the pump, grasp the pump cylinder (12) with two hands and firmly pull the pump assembly from the magnet housing.

On SMVP200B/300B models: Attach an appropriately sized hoist to the pump to prevent the pump from dropping when the magnets release. Remove motor housing adapter capscrews (54B). Starting from the motor side of the magnet housing, thread the two jackscrews (54C) into the holes of the housing. The jackscrews will force the motor away from the housing to release the magnets. The jackscrews should remain in the magnet housing to aid in future reassembly of the pump

and housing. Using the hoist, pull the pump assembly from the magnet housing.

5. Remove the containment can (50) from the inboard head, using a slight pry, if necessary. DO NOT damage the containment can or pump head. Remove and discard the containment can O-ring (51).
6. Remove the impeller (52A) from the inner magnet by removing the three impeller capscrews and washers (52B & 52C)

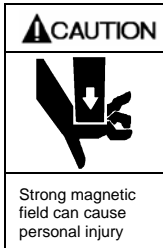

Failure to use care when handling magnets can cause personal injury

7. With properly sized snap ring pliers, remove the snap ring (83) from the shaft end. Pull the inner magnet (52) from the shaft. Remove the shaft key (35).
8. Remove the eight socket head capscrews (21) from the inboard head and bearing assembly (20). Carefully slide the inboard head assembly off the shaft. A pry may be necessary to separate the head and cylinder. DO NOT damage head, cylinder / casing or shaft.

On SMVP200B/300B models, remove and discard the inner head O-ring (72A).

9. Remove the disc (71) and head seal ring / O-ring (72) from the cylinder / casing. Discard the head seal ring / O-ring.
10. Carefully pull the rotor and shaft assembly (13) from the cylinder while preventing the vanes (14) and push rods (77) from falling out of the rotor. Set the rotor and shaft assembly aside for future vane replacement and reassembly.
11. Remove the four bearing cover capscrews (28) and the bearing cover (27). Remove and discard the bearing cover seal ring (26).
12. Remove the eight outboard head capscrews (21 A) and the outboard head and bearing assembly (23). Remove the disc (71) and head seal ring / O-ring (72). Discard head seal ring / O-ring. Use care not to let the disc fall and become damaged.
13. MVP models only. Remove the liner (41) by uniformly tapping around the outside diameter of the liner with a hard wood drift and a hammer until it is driven from the casing.

14. RELIEF VALVE DISASSEMBLY (if equipped)

- a. Remove the valve cap (1) turn the adjusting screw (2) to relieve the spring pressure.
- b. Remove the relief cover capscrews (5) and relief valve cover (4)
- c. Remove the spring guide (7), spring (8), and valve (9) from the relief valve bore.

MAINTENANCE

MAGNET HOUSING DISASSEMBLY

1. Remove the four housing/adapter capscrews (54B), and pull the motor, motor adapter (86) and outer magnet (53) from the magnet housing (57).
2. Remove the motor adapter capscrews (56), and the motor adapter (86) from the motor.
3. Place a flat wrench or "plate" between the three bushing capscrews and the "C" face of the motor. Loosen the three capscrews located in the bushing (87) allowing them to bottom out against the flat wrench or "plate" and assist in removing the outer magnet. If room allows for the screws to be removed completely, the bushing is predrilled with jacking holes for the purpose of removing the outer magnet from the bushing.
4. When outer magnet has been removed from the bushing, loosen setscrew and remove bushing and keyway from the motor shaft.
5. Pump and magnet housing disassembly is complete.

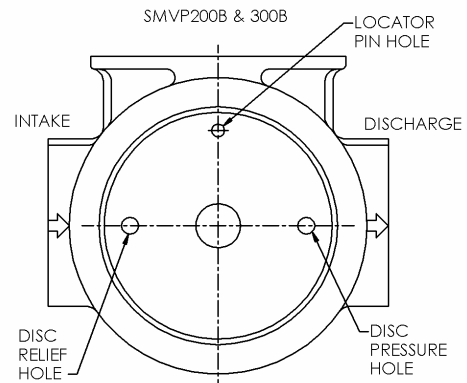
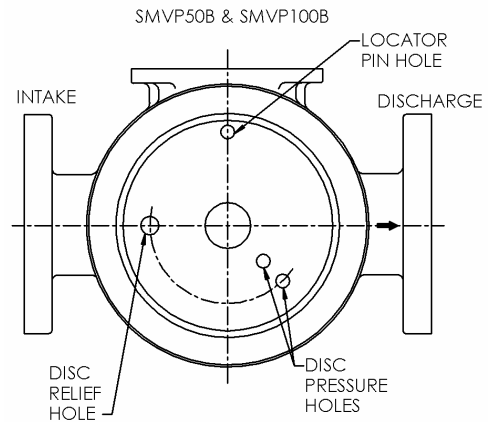

Figure 4 – SMVP Models

2. Install the disc (71) on the outboard end of the cylinder with the disc holes positioned as shown in Figure 4. Use the dowel locator pin hole to locate the disc.
3. Install a new head seal ring / O-ring (72) in the groove provided between the disc and the cylinder.

PUMP ASSEMBLY

NOTICE:

Follow all hazard warnings and instructions provided in the "maintenance" section of this manual.

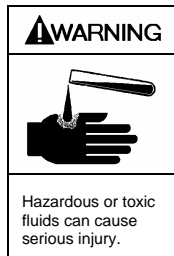

Containment can failure will permit fluid leakage and can cause serious injury.

Before reassembling the pump, all parts should be thoroughly cleaned and inspected for wear, damage, and replaced as necessary. Remove any burrs from the rotor and mating cylinder (SMVP) or liner (MVP).

NOTICE:

The containment can (50) must be replaced if any corrosion, cracking, wear or other damage is present.

1. Begin assembly on the outboard side of the pump, by laying the pump cylinder (12) on a flat surface with the intake port to the LEFT.

MAINTENANCE

4. Inspect both sleeve bearings (24) for damage or wear. If damaged, bearings **MUST** be replaced.

On SMVP50B/100B models: if the inside diameter of the bearing measures 1.196" (30.38mm) or greater at any point around the entire circumference, bearings **MUST** be replaced.

On SMVP200B/300B models: if the inside diameter of the bearing measures 1.765" (44.83mm) or greater at any point around the entire circumference, bearings **MUST** be replaced.

To replace bearings:

- a. Using an appropriately sized arbor press, remove the old bearing from the head.
 - b. To aid installation and prevent damage, heat the head in an oven to 200°F (93°C).
 - c. Coat the new bearing with a quality grade of bearing grease, and place it on the inside face of the head with the notched end UP. **Align the notch in the bearing with the groove in the head.**
 - d. Using an arbor press, **CAREFULLY** press the bearing into the head until it is flush with the inside face of the head. Ensure that the bearing does not become misaligned during the pressing activity.
 - e. On SMVP200B/300B models, lightly grease the inner head O-ring (72A) using a silicone base O-ring lubricant. Install into the O-ring recess on the inside face of the head. The grease will hold the O-ring in place during head installation.
4. Install the outboard head and bearing assembly (23) on the pump cylinder with the V-notch down, towards the bottom of the cylinder. Use the head dowel pins for proper alignment.
 5. For SMVP Models lubricate the eight outboard head capscrews (21A) with a quality grade of anti-seize compound and install, torquing to 15 lbs-ft(20.3Nm).
For MVP Models install and uniformly tighten the eight outboard head capscrews (21A), torquing to 40 lbs ft (54 Nm).
 7. Install a new bearing cover O-ring / seal ring (26) in the groove in the outboard head / bearing cover. Place the bearing cover (27) on the head.
For SMVP Models lubricate the bearing cover capscrews (28) with a quality grade of anti-seize compound, and install, torquing to 15 lbs-ft(20.3Nm).
For MVP Models install the bearing cover capscrews (28), torquing to 30 lbs ft (41 Nm).
 8. Turn the pump cylinder / casing over so that it rests on the just installed outboard head and bearing cover.
 9. Remove the six vanes (14) and three push rods (77) from the rotor assembly. Inspect for wear and damage, and replace as follows:
 - a. The push rods **MUST** be installed before installing the rotor and shaft (13) into the pump cylinder / casing. To do so, hold the rotor and shaft vertical, with the non-driven (shorter end) down. Slide the push rods into the push rod holes of the rotor, then insert the rotor and shaft into the open end of the pump cylinder / casing.

- b. Insert new vanes into the rotor slots with the rounded edges outward, and the vane relief grooves facing **TOWARDS** the direction of rotation. Refer back to Figure 3. If necessary, move the push rods with a small screwdriver to install the vanes.

10. Install the inboard disc (71), head seal ring / O-ring (72), and sleeve (24) bearing as instructed in steps 2 through 4 above.
11. Install the inboard head and bearing assembly (20) on the pump cylinder / casing with the V-notch down, towards the bottom of the cylinder / casing. Use the head dowel pins for proper alignment.
12. For SMVP Models lubricate the eight inboard head capscrews (21) with a quality grade of anti-seize compound, and install, torquing to 15 lbs ft (20.3Nm).
For MVP Models install and uniformly tighten the eight inboard head capscrews (21), torquing to 40 lbs ft (54 Nm).

RELIEF VALVE ASSEMBLY (If Equipped)

1. Insert the valve (9) into the relief valve bore of the casing with the fluted end inward.
2. Install the relief valve spring (8) and spring guide (7) against the valve.
3. Attach a new relief valve O-ring (10) and the valve cover (4) on the cylinder.
4. Screw the relief valve adjusting screw (2) with locknut (3) into the valve cover (4) until it makes contact with the spring guide (7).

NOTICE:

The relief valve setting **MUST be tested and adjusted more precisely before putting the pump into service. Refer to "Relief Valve Setting and Adjustment"**

5. After the relief valve has been adjusted, tighten the Locknut (3) and install the relief valve cap (1) and O-ring (88)

MAGNET HOUSING ASSEMBLY

INNER MAGNET & PUMP ASSEMBLY

1. Install the shaft key (35) on the inboard shaft end.
2. Align the inner magnet (52) with the key, and slide the magnet over the shaft with the pump end of the magnet towards the inboard head.
3. Fully and squarely install the snap ring (83) into the groove in the end of the shaft.
4. Place the impeller (52A) against the inner magnet. Lubricate the impeller capscrews (52B) with anti-seize compound. Attach the impeller to the magnet with the capscrews and lockwashers (52B, 52C).
5. Check to ensure the pump shaft rotates freely when turned by hand.

Install a new containment can O-ring (51) into the groove provided on the hub of the inboard head (20). Slide the containment can (50) over the magnet and push it firmly against the inboard head.

MAINTENANCE

6. Using an appropriately sized hoist CAREFULLY slide the pump assembly into the mounted magnet housing.
On SMVP200B/300B models if motor, adapter ring, and outer magnet are in place, the jackscrews (54C), installed in the magnet housing during disassembly, will hold the motor partially out of the housing. Gradually unscrew the jackscrews to allow the motor to fully engage in the housing.
With the magnet housing fully and squarely seated, install the four housing capscrews (54B), torquing to 27lbs ft (36.6 Nm).
7. Apply anti-seize compound to the four housing / head capscrews (54A) and install, torquing to 27 lbs ft (36.6 Nm).

OUTER MAGNET ASSEMBLY

Follow instructions given in the MOTOR INSTALLATION Section of this Manual.

FINAL ASSEMBLY

When Outer Magnet & Motor have been installed correctly.

1. Reinstall the piping to the pump intake and discharge connections.
2. Reassembly is complete.

NOTICE:

Follow all steps in the "operation" section of this manual for start up procedures.

TROUBLESHOOTING

NOTICE:

Maintenance shall be performed by qualified technicians only, following the appropriate procedures and warnings as presented in this manual.

PROBLEM	CAUSE
Pump Not Priming See causes 1 through 7	1. Suction/discharge valve incorrectly set.
Reduced Capacity See causes 1 , 2, 3, 6 through 10	2. Leaks in suction piping.
Noisy See causes 1, 6, 7, 8, 9, 11 through 14	3. Incorrect rotation.
Damaged Vanes See causes 8, 11, 16 through 21	4. Broken shaft.
Broken Shaft See causes 7, 11, 13, 16, 17&20	5. Pump vapor locked.
Motor Overload See causes 9, 13, 17, 22 & 23	6. Incorrect pump speed.
	7. Vanes damaged, worn or incorrectly installed.
	8. Cavitation.
	9. Damaged or worn pump or system components.
	10. Excessive piping/system friction losses.
	11. Relief valve incorrectly set, worn or damaged.
	12. Operating against a closed discharge.
	13. Shaft bent or misaligned.
	14. Worn or damaged bearings.
	15. Piping inadequately anchored.
	16. Foreign objects entering the pump.
	17. Viscosity too high
	18. Excessive heat.
	19. Worn or damaged push rods.
	20. Hydraulic hammer - pressure spikes.
	21. Incompatible fluid(s).
	22. Inadequate horsepower.
	23. Incorrect voltage, wiring, phase loss.

