

BLACKMER AIR VALVE

INSTALLATION OPERATION AND MAINTENANCE INSTRUCTIONS & PARTS LIST
**For Pump Models: TXD2A-AVA, TXD2.5A-AVA, TXD3E-AVA,
TXH3A-AVA**

TABLE OF CONTENTS	Page
SAFETY DATA	1-2
VALVE DATA	2
Air Valve Technical Data	2
Initial Air Valve Settings.....	2
INSTALLATION	2
Pre-Installation Cleaning	2
Mounting the Air Valve	3
Air Valve Adjustment.....	3
TANK TRUCK FUEL OIL DELIVERY OPERATION	4
Air Systems	4
Electric / Hydraulic Systems.....	4
MAINTENANCE	5
Maintenance and Inspection Schedules.....	5
Air Valve Removal and Disassembly.....	5
Air Valve Assembly.....	6
PARTS LIST	7

NOTICE:
Review and follow all hazard warnings provided in the appropriate Blackmer pump installation, operation and maintenance instruction manual

NOTE: Blackmer pump manuals & parts lists may be obtained from Blackmer's website (www.blackmer.com) or by contacting Blackmer Customer Service

PUMP MODEL	PUMP INSTRUCTION MANUAL	PUMP PARTS LIST		
		2"	2.5"	3"
TXD	201-A00	201-A02	201-A03	201-A04
TXH3	201-C00	201-C01		

NOTE: Numbers in parentheses following individual parts indicate reference numbers on Blackmer Parts List

SAFETY DATA



This is a SAFETY ALERT SYMBOL.
When you see this symbol on the product, or in the manual, look for one of the following signal words and be alert to the potential for personal injury, death or major property damage



Warns of hazards that WILL cause serious personal injury, death or major property damage.



Warns of hazards that CAN cause serious personal injury, death or major property damage.



Warns of hazards that CAN cause personal injury or property damage.

NOTICE:
Indicates special instructions which are very important and must be followed.

NOTICE:

Blackmer Air Valves **MUST** only be installed in systems which have been designed by qualified engineering personnel. The system **MUST** conform to all applicable local and national regulations and safety standards.

This manual is intended to assist in the installation and operation of the Blackmer Air Valves, and **MUST** be kept with the pump.

Blackmer Air Valve service shall be performed by qualified technicians **ONLY**. Service shall conform to all applicable local and national regulations and safety standards.

Thoroughly review the pump manual and all Air Valve instructions and hazard warnings, **BEFORE** performing any work on the Blackmer Air Valves.

Maintain **ALL** system and Blackmer air valve pump operation and hazard warning decals.

SAFETY DATA

⚠ WARNING



Hazardous machinery can cause serious personal injury or property damage.

Failure to set the vehicle emergency brake and chock wheels before performing service can cause severe personal injury or property damage.

⚠ WARNING



Hazardous pressure can cause personal injury or property damage.

Disconnecting fluid or pressure containment components during pump operation can cause serious personal injury, death or major property damage

⚠ WARNING



Hazardous machinery can cause serious personal injury.

Failure to disconnect and lockout electrical power or engine drive before attempting maintenance can cause serious personal injury or death

⚠ WARNING



Hazardous or toxic fluids can cause serious injury.

If pumping hazardous fluids system must be flushed and decontaminated prior to performing service or maintenance.

⚠ WARNING



Hazardous fluids can cause fire, serious personal injury or property damage.

All fluids pumped must be compatible with diaphragm material. Incompatibility can cause fire, serious personal injury or property damage.

⚠ WARNING



Hazardous pressure can cause serious personal injury or property damage.

Failure to relieve system pressure prior to performing pump service or maintenance can cause personal injury or property damage.

NOTICE:

Installation and maintenance should be performed by qualified technicians only, following the appropriate procedures and warnings as presented in this manual and the appropriate pump installation, operation, and maintenance instructions.

VALVE DATA

AIR VALVE TECHNICAL DATA

Maximum Pump Pressure	125 psi (8.6 Bar)
Maximum Air Pressure	125 psi (8.6 Bar)
Minimum Air Pressure	70 psi (4.8 Bar)
Maximum Operational Temperature	240°F (115°C)
Minimum Operational Temperature	-20°F (-29°C)

INITIAL AIR VALVE SETTINGS

Pump Operating Pressure:	_____
Low Pressure Setting:	_____
High Pressure Setting:	_____
Peak Pressure Setting:	_____

INSTALLATION

The Blackmer Air Valve is a diaphragm type actuator (see parts list drawing on page 6). The air valve is designed to work with a flow sensing pilot valve (air or electric) which puts pressure behind the diaphragm when the nozzle is open and fluid is flowing. This permits high pressure operation of the pump. When the nozzle is closed and flow is stopped, the flow sensing pilot valve relieves the actuating pressure from behind the diaphragm and the pump will automatically go into low pressure bypass.

Approximately 70 psi (4.8 bar) minimum air pressure is required to properly operate the air valve control system. Air pressure MUST NOT exceed 125 psi (8.6 bar).

PRE-INSTALLATION CLEANING

Foreign matter entering the pump WILL cause extensive damage. The pump and the surrounding area MUST be cleaned prior to attempting air valve installation.

NOTICE:

The Blackmer air valve is designed for fuel oil service. Contact factory for all other fluids.

NOTICE:

A preset, spring loaded air check valve must be installed in the vehicle air supply line to ensure minimum safe air pressure for the brake system.

INSTALLATION

MOUNTING THE AIR/RELIEF VALVE

1. Remove the pump relief valve cap (1) and turn the adjusting screw (2) counterclockwise to relieve spring tension.
2. Remove and discard the pump's four relief valve cover bolts (5 & 5C). Remove the cover assembly (4), spring guide (7), spring (8), and gasket (10). Clean and inspect the gasket surfaces, repairing as necessary.
3. Install a new gasket (10).

NOTICE:

The relief valve spring must be confined between the boss on the air valve (9) and the boss on the diaphragm assembly (9c).

4. Attach the Blackmer Air Valve assembly to the pump using the four new bolts provided (5 & 5C). Ensure the valve cover (4) is positioned so that the air inlet pipe hole is accessible to attach the air or hydraulic line.
5. Torque the air valve mounting bolts as indicated in Table 1.

PUMP MODEL	TORQUE * - lbs in (Nm)
TXD2A-AVA	150(16.9)
TXD2.5A-AVA, TXH3A-AVA, TX200B-AVA	175 (19.8)
TXD3E-AVA	225 (25.4)

*Torque specification tolerance is +/- 10 lbs in (1.08 Nm).

Table 1

AIR/RELIEF VALVE ADJUSTMENT

NOTICE:

Maintenance should be performed by qualified technicians only, following the appropriate procedures and warnings as presented in this manual and the appropriate pump installation, operation, and maintenance instructions.



Failure to relieve system pressure prior to performing pump service or maintenance can cause personal injury or property damage.

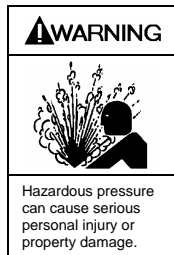

Incorrect settings of the Blackmer air valve can cause system component failure, personal injury and property damage.

NOTICE:

If the air valve snap ring (83) is removed, and the locknuts turned out beyond the snap ring, the diaphragm (9c) will be damaged allowing pumpage to leak to the atmosphere.

The Blackmer Air Valve low and high pressure settings are adjustable within a specific range to suit the engine operating speed and operating conditions. Refer to Table 2 for the air valve pressure settings. Attach a suitable pressure gauge at the pump discharge gauge port (73) to make the required air valve adjustments. Record the air valve and pump operating pressures in the "Initial Air Valve Settings" chart.

PRESSURE	SETTING / RANGE – PSI (bar)
Pump Operating	100 (6.9) Maximum
Low	10-35 (.69 –2.4)
High	70-125 (4.8-8.6); 125 (8.6) Maximum – Do Not Exceed
Peak	15-25 (1.0-1.7) above normal operating pressure

Table 2 – Blackmer Diaphragm Air Valve Settings – All Models

Low Pressure Adjustment:

The air valve low pressure adjustment MUST be set first.

NOTICE:

The air valve low pressure setting regulates the delivery hose pressure when the nozzle is closed. Adjust the air valve only high enough to open the flow sensing valve.

1. Adjustment MUST be made with the pump at normal idle speed - 200 RPM minimum.
2. SLOWLY close the delivery nozzle, allowing the pressure to be relieved inside the air valve cap.
3. Remove the air valve cap (1) and O-ring (88).
4. Turn the adjusting bushing (2C) clockwise to increase the pressure setting, or counterclockwise to decrease the pressure setting. Refer to Table 2 for setting ranges.
5. Install O-ring and air valve cap; tighten the cap securely.
6. Open and close the delivery nozzle several times to ensure the correct setting.

High Pressure Adjustment: - Do not exceed the maximum pressure listed in Table 2.

1. Adjustment MUST be made with the pump at normal operating speed and with pressure behind the air valve diaphragm.
2. Slowly close the delivery nozzle, allowing the pressure to be relieved inside the air valve cap.
3. Remove the air valve cap.

NOTICE:

To avoid damage to the diaphragm (9c) always use a counter wrench (opposing wrench) when tightening the locknuts (2A). Always start with the locknuts turned all the way down, clockwise, against the adjusting bushing.

4. Adjust the locknuts counterclockwise to increase the pressure setting or clockwise to decrease the pressure setting, until the required high pressure setting is achieved. See Table 2 for setting ranges.
5. Install the air valve cap securely.
6. Open the delivery nozzle and observe the pump's discharge gauge. Repeat steps 2-5 until required high pressure setting is achieved.
7. After the final adjustment is made, ensure that the locknuts (2A) are tight. Inspect the air valve cap O-ring (88) and replace as necessary.

NOTICE:

Where regulations require, holes in R/V Cap (1) and capscrew with hole (5C) are used by the weights and measures official (s) to apply a security seal or tag.

TANK TRUCK FUEL OIL DELIVERY OPERATION

Air Systems for Automatic Pressure and Speed Control

The pump is equipped with an adjustable spring actuated relief valve. The spring bears against a diaphragm. With the air pressure on the diaphragm, the valve controls pressure in the conventional manner. When air pressure is removed, the relief valve opens wide, reducing the system pressure.

The pilot valve senses flow. It closes when the nozzle closes and removes air pressure from the pump air valve and the air cylinder on the engine speed control.

When the nozzle is opened, the liquid flow actuates the pilot valve. Air pressure on the air cylinder then speeds up the engine and pump to a preset value and, by pressurizing the pump air valve, increases the system pressure to obtain the desired flow.

Closing the nozzle automatically reduces the engine and pump speed to an idle, and reduces the system pressure, making the hose easier to handle. The net effect also reduces wear and tear on the equipment.

The nozzle may be partially closed to "top off" a tank in the same manner as when a Blackmer pump with the standard relief valve is used.

The engine speed control air cylinder should be rigidly mounted to prevent variations in the speed control.

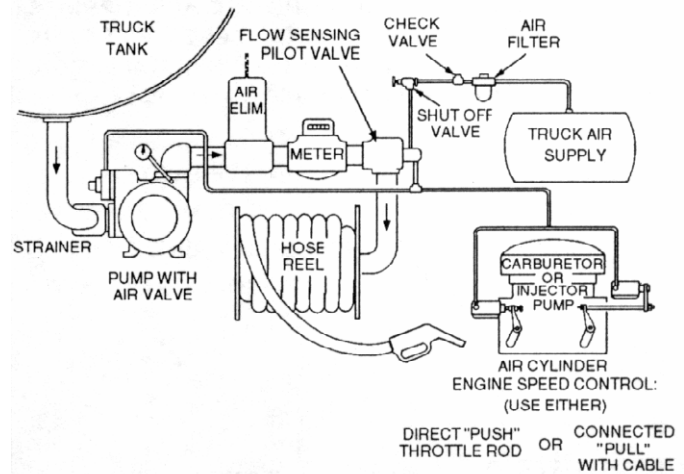

Figure 1 - Air System

Electric/Hydraulic Systems for Automatic Pressure and Speed Control

⚠ DANGER

Explosive fluids will cause severe personal injury, death or major property damage.

Failure to provide full flow discharge piping, a properly grounded system and system components will cause static electricity, incendiary sparks and ignition of explosive liquids.

The pump is equipped with an adjustable spring relief valve. The spring bears against the diaphragm. With pump discharge pressure on the diaphragm, the valve controls pressure in the conventional manner. When the pump discharge pressure is removed, the relief valve opens wide, reducing the system pressure.

The flow switch "senses" flow. With the pump running and the nozzle open, liquid causes the electrical switch to close and energize the solenoids. The solenoid on the carburetor or injection pump causes the engine and pump to speed up to a pre-set value. At the same time, the solenoid valve at the pump uses the pump discharge pressure to change the bypass setting at the pump, increasing the system pressure to obtain the desired flow.

Closing the nozzle opens the flow switch, automatically reduces the engine speed to an idle, and reduces the system pressure, making the hose easier to handle. The net effect also reduces wear and tear on the equipment. The nozzle may be partially closed to "top off" a tank in the same manner as when a Blackmer pump with the standard relief valve is used.

The engine speed control solenoid should be rigidly mounted to prevent variations of the engine speed.

⚠ WARNING

Hazardous fluids can cause fire, serious personal injury or property damage.

Failure to mount the 3-way pneumatic valve away from heat, flame, sparks or outside the engine compartment can cause fire, personal injury or property damage.

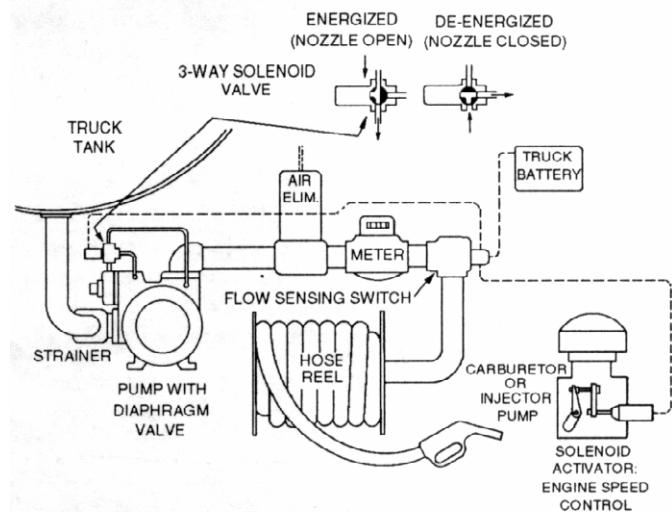



Figure 2 - Electric / Hydraulic System

MAINTENANCE

NOTICE:

Maintenance should be performed by qualified technicians only, following the appropriate procedures and warnings as presented in this manual and the appropriate pump installation, operation, and maintenance instructions.

WARNING



Hazardous machinery can cause serious personal injury or property damage.

Failure to set the vehicle emergency brake and chock wheels before performing service can cause severe personal injury or property damage.

WARNING



Hazardous machinery can cause serious personal injury.

Failure to disconnect and lockout electrical power or engine drive before attempting maintenance can cause serious personal injury or death.

WARNING



Hazardous fluids can cause fire, serious personal injury or property damage.

All fluids pumped must be compatible with diaphragm material. Incompatibility can cause fire, serious personal injury or property damage.

WARNING



Hazardous pressure can cause personal injury or property damage.

Disconnecting fluid or pressure containment components during pump operation can cause serious personal injury, death or major property damage.

WARNING



Hazardous or toxic fluids can cause serious injury.

If pumping hazardous fluids system must be flushed and decontaminated prior to performing service or maintenance.

WARNING



Hazardous pressure can cause serious personal injury or property damage.

Failure to relieve system pressure prior to performing pump service or maintenance can cause personal injury or property damage.

AIR VALVE MAINTENANCE AND INSPECTION SCHEDULES

Valve Assembly Part	Inspection Schedule	Action Required
Vent Plate (6A)	Weekly	If leakage is present, IMMEDIATE valve service is required. DO NOT remove grease from vent hole.
Air Valve Assembly	Annually	Disassemble, inspect diaphragms and replace if cracked or blistered.
Diaphragm (9C)	3 Years (or less)	REPLACE

AIR VALVE REMOVAL AND DISASSEMBLY

- Remove the cap (1) from the air valve assembly. Remove and discard the cap O-ring (88).
- Remove the snap ring (83) and locknuts (2A) from the adjusting rod. Turn the adjusting bushing (2C) counterclockwise to reduce spring tension.
- Remove the four capscrews (5 & 5C) and lockwashers (5B).
- Carefully remove the air valve assembly, spring (8), and if necessary, the valve (9).
- Remove and discard the gasket (10). Clean gasket areas.
- Remove the two machine head screws (5A), valve plate (6), diaphragm assembly (9C), and vent plate (6A). Discard the diaphragm assembly.
- Thread the adjusting bushing (2C), CLOCKWISE completely into the valve cover (4).

AIR VALVE ASSEMBLY

1. Remove the snap ring (83) from the adjusting rod on the new diaphragm assembly (9C).

NOTICE:

Prior to assembly, the area around the spacer between the diaphragms and the inner diameter of the vent plate must be greased with a lithium based grease. Remove any grease from the outer diameter of the vent plate and diaphragm surfaces.

2. Being careful not to damage the diaphragm, place the vent plate (6A) between the two diaphragms by pulling the pump side diaphragm corners through the center hole in the vent plate.
3. Insert the new diaphragm assembly into the adjustment bushing (2C).
4. Install the plate (6) on the air valve with the holes in the diaphragm, vent plate and plate lined up. Attach the assembly with the two machine screws (5A), tightening securely.
5. Install both locknuts (2A) all the way down to the adjusting bushing and replace the snap ring (83).
6. Install a new gasket (10) and insert the four capscrews (5 & 5C) with lockwashers (5B) into the air valve assembly.

NOTICE:

The relief valve spring must be confined between the boss on the air valve (9) and the boss on the diaphragm assembly (9c).

7. If removed, reinstall the valve (9). Place the spring (8) between the boss on the diaphragm assembly and the valve. Mount the air valve assembly to the pump, ensuring that the gasket is properly seated. Torque the capscrews (5 & 5C) to the appropriate value depicted in Table 1.
8. With a new O-ring (88) installed, attach the air valve cap (1) securely.
9. Adjust the new valve as provided in the "Air Valve Adjustment" section of this manual.

NOTES

PARTS LIST

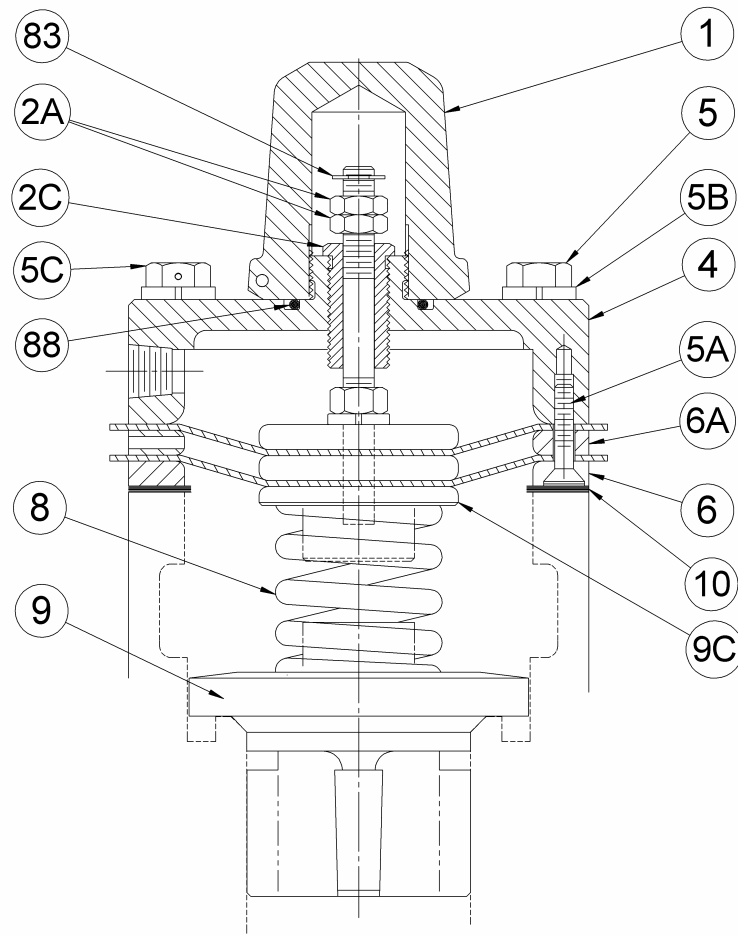

REF. NO.	PART NAME	PARTS PER VALVE	TXD2A-AVA PART NO.	TXD2.5A-AVA, TX200B-AVA PART NO.	TXD3E-AVA PART NO.	TXH3A-AVA, PART NO.
1	Cap	1	411754	411754	411754	411753
2A	Locknut	2	922923	922923	922923	922923
2C	Adjustment Bushing	1	501701	501701	501701	501701
4	Cover	1	411406	411703	411705	411703
5	Capscrew	3-4	920444	920444	920444	920239
5A	Machine Screw	2	922216	922216	922216	922216
5B	Lockwasher	4	909649	909649	909649	909693
5C	Capscrew w/ Hole	0-1	920433	920433	920433	—
6	Plate	1	701400	701735	701737	701735
6A	Vent Plate	1	701418	701618	701818	701618
8	Spring	1	471429	471621	471806	471621
9	Valve **	1	451417	451623	451807	451623
9C	Diaphragm Assembly	1	871175	871180	871185	871180
10	Gasket	1	531403	531603	531803	531603
83	Snap Ring	1	903581	903581	903581	903581
88	O-Ring	1	711917	711917	711917	711917
	A/V Conversion Kit **	—	891454	891696	891798	891799

* NOTE: The double diaphragm air valve assembly replaced the single diaphragm assembly in Aug. 1991.

** A/V Conversion Kit includes all above parts EXCEPT the Valve (ref. 9).

